

CRX et CRX solaire

issu de la gamme  PROFIALIS



Vous accompagne dans la pose et la mise en service de vos produits Eveno

EVENO

Les éléments de votre Confort



Sommaire

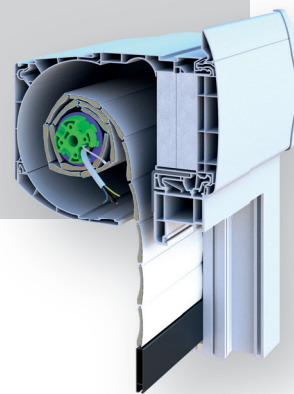

CRX & CRX Solaire PRÉSENTATION

- Page 4-5 | Nuancier
COULEURS
- Page 6-8 | Planches Schémas
TECHNIQUES
- Page 9 | Caractéristiques
TECHNIQUES
- Page 9 | RAPPORT
Acoustique
- Page 10-11 | Automatismes
COMMANDES
- Page 12 | Contact
SECTEURS COMMERCIAUX

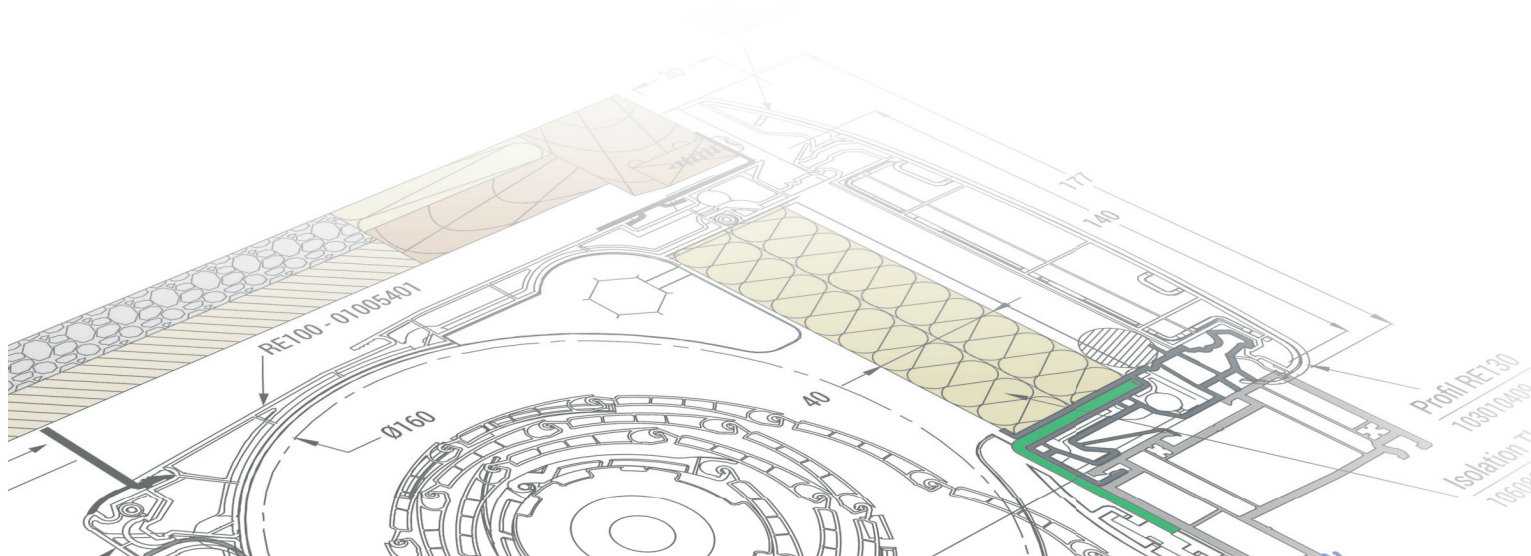
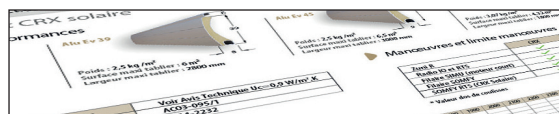
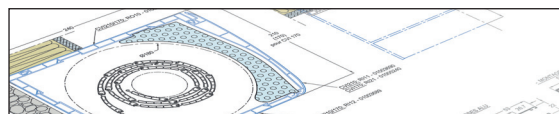

Tablier, coulisses et lame finale au prix du blanc



















	Alu Ev 39	Alu Ev 45	PVC 40	Coulisses Alu 60x28	Coulisse PVC	Lame finale
Délai 1 semaine						
RAL 7016	●	●		●		●
RAL 9006 Aluminium	●	●				●
RAL 7035 Gris clair	●	●	●			●
RAL 8019	●	●				●
RAL 1015	●	●				●
Chêne doré	●	●				●
Noir 2100 ⁽¹⁾ fine structure	●	●				●
Délai 2 semaines						
RAL 9005	●	●				●
Gregorex	●		●			●
RAL 3004	●	●				●

⁽¹⁾ Fine structure = Ral Sablé ou texturé



La parfaite similitude entre des produits d'origine différente et de même teinte RAL ne peut être garantie (une tolérance étant admise par le standard RAL)

Tablier, coulisses et lame finale avec plus-value

	Alu Ev 39	Alu Ev 45	Coulisses Alu 60x28	Lame finale		Alu Ev 39	Alu Ev 45	Coulisses Alu 60x28	Lame finale
	Délai 1 semaine					Délai 2 semaines			
THR Blanc 9016					Gris 2900 fine structure				
THR RAL 7016					RAL 8014				
THR Chêne doré					RAL 1013				
					RAL 7022				
					RAL 7015				
					RAL 7039				
					RAL 9007				

Autres coloris coffre, coulisses, lame finale et tablier

Coffre	Beige grégorex, gris teinté masse
	Coffre chêne doré
	Laquage autre RAL (par planche)
Coulisses PVC (la paire)	Beige grégorex, gris teinté masse
	Plaxé chêne doré
	Laquées autre RAL
Coulisse Alu (la paire)	Autres teintes RAL que celles au prix du blanc
Lame finale	Autres teintes RAL que celles au prix du blanc
Tablier	Alu extrudé 37 (uniquement tablier motorisé)

CRX & CRX Solaire

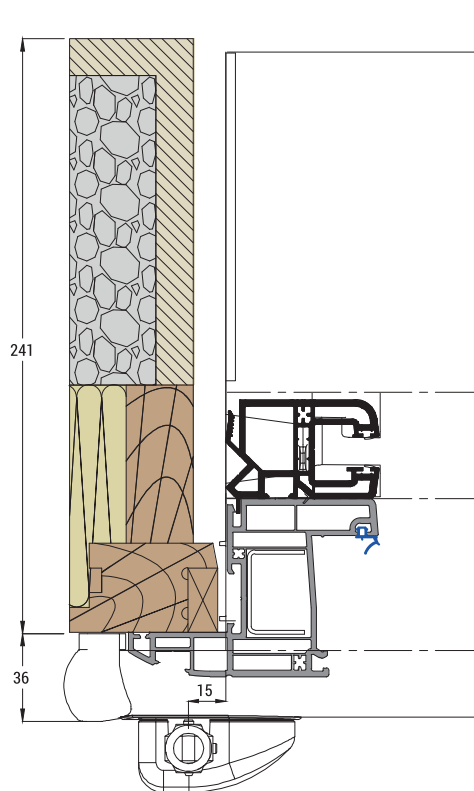
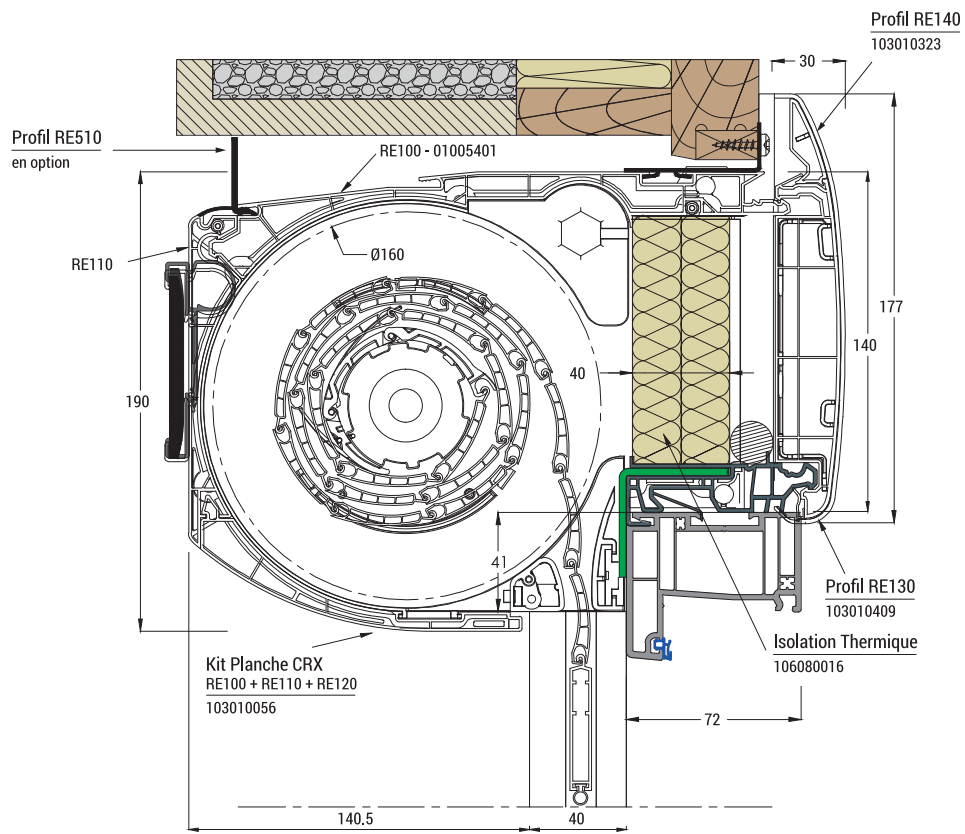

Coulisses PVC

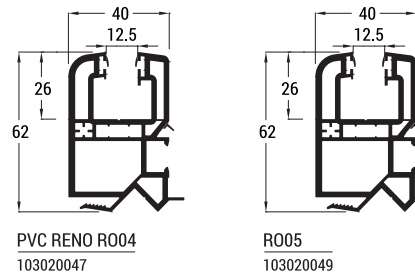

Coulisses Alu

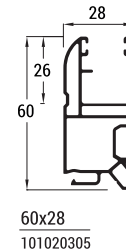

Montage coulisses double

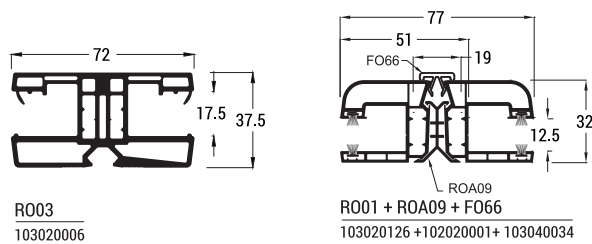

Elargisseurs Coulisse Alu 60x28 sous Réserve d'intégration

(Permet de dégager la coulisse des ouvrants)

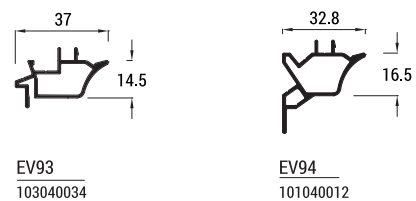

Adaptateurs



RE530
Dormant 60 mm
103040003



RE561
Dormant 70 mm / 72 mm
103040004



RE560 D Délégué
Dormant 70 mm à 74 mm
103040001

Accessoires



RE510
Profil de finition Ext (Option)
103010009

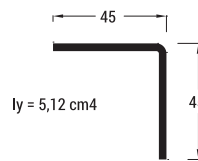

RE530
Cornière de Renfort
103040003

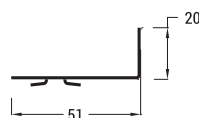

REA630
Patte de Reprise Dormant 60 mm
204010188
A partir de 1700 mm Dos de Coulisse

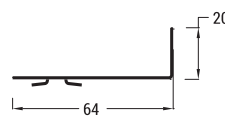

REA660
Patte de Reprise Dormant 70 mm
204010153
A partir de 1700 mm Dos de Coulisse



REA650
Patte de Reprise Dormant 72 mm
204010156
A partir de 1700 mm Dos de Coulisse

Eclaté CRX & CRX solaire

Montage moteur Zuni R / Zigbee

Axe diamètre 56

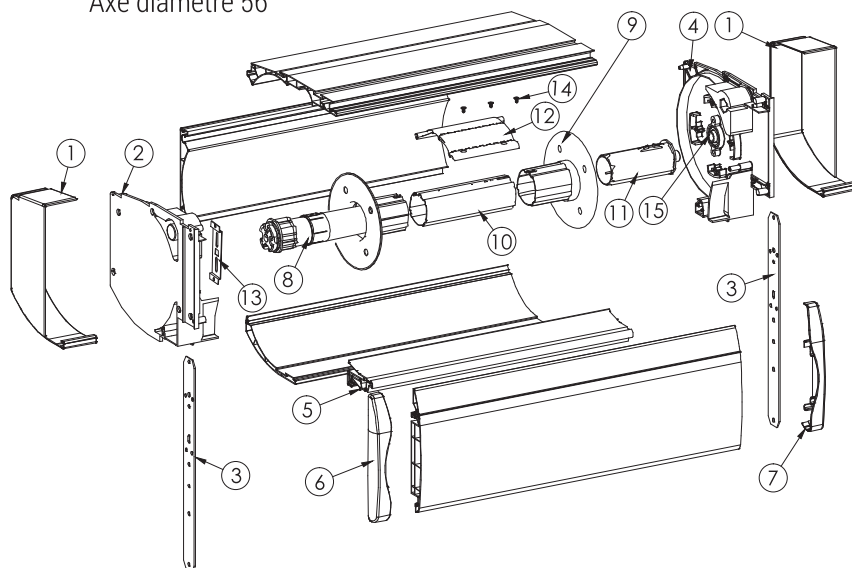

N°	Désignation	Code Article
1	Paires Caches Extérieur	203010090
2	Joue G Côté Manœuvre	203010240
2	Joue D Côté Opposé Manœuvre	203010238
3	Paires Feuillard	204010012
4	Joue D Côté Manœuvre moteur	203010233
4	Joue D Côté Opposé moteur	203010231
5	Adaptateur Dormant 60 mm	103040003
5	Adaptateur Dormant 70 mm Délégné	103040001
6	Embout Réno Droit	203010166
7	Embout Réno Gauche	203010169
8	Moteur Zuni R/ Zigbee	
9	Flasque	203010312
10	Axe Diam 56 mm Ep 0,5 mm	
11	Embout d'axe	203060075
12	Verrou automatique	202060007
13	Support Moteur	
14	Vis Verrou	
15	Palier Lisse Diam 18 mm	203010263

Montage treuil

Axe diamètre 56

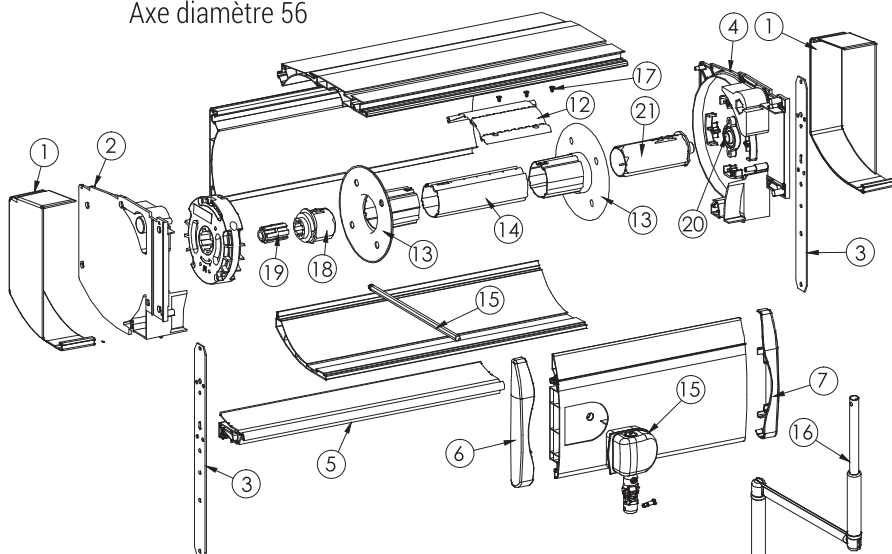

N°	Désignation	Code Article
1	Paires Caches Extérieur	203010090
2	Joue G Côté Manœuvre	203010242
2	Joue D Opposé Manœuvre	203010238
3	Patte Feuillard	204010012
4	Joue D Côté Manœuvre	203010233
4	Joue D Côté Manœuvre Treuil Crabot	203010235
5	Adaptateur Dormant 60 mm	103040003
5	Adaptateur Dormant 70 mm Délégné	103040001
6	Embout Réno Droit	203010166
7	Embout Réno Gauche	203010169
12	Verrou automatique	202060007
13	Flasque	203010312
14	Axe Diam 56 mm Ep 0,5 mm	
15	Bloc Genouillère G	203060017
16	Manivelle Select Alu	201060016
17	Vis Verrou	
18	Embout de compensation	203060054
19	Embout Mâle	203060119
20	Palier Lisse Diam 18 mm	203010263
21	Embout d'axe Diam 18 mm	203060188

Montage Coulisse double

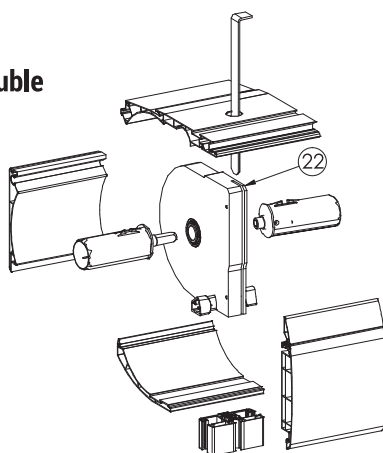

N°	Désignation	Code Article
22	Joue Coulisse Double	203010246

■ Performances

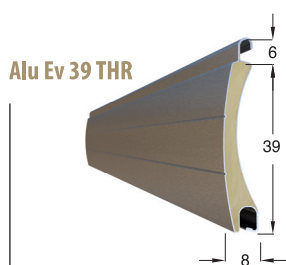

Alu Ev 39 THR

Poids : 2,75 kg /m²
 Surface maxi tablier : 6 m²
 Largeur maxi tablier : 2800 mm
 $\Delta R = 0,25 \text{ m}^2 \cdot \text{K/W}^*$

*en TO et en moteur

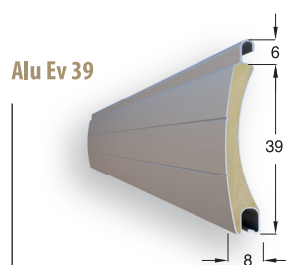

Alu Ev 39

Poids : 2,75 kg /m²
 Surface maxi tablier : 6 m²
 Largeur maxi tablier : 2800 mm
 $\Delta R = 0,18 \text{ m}^2 \cdot \text{K/W}^*$

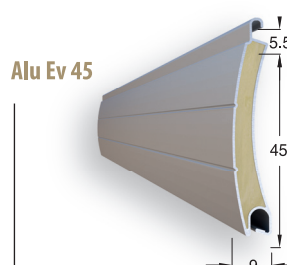

Alu Ev 45

Poids : 3,16 kg /m²
 Surface maxi tablier : 7,4 m²
 Largeur maxi tablier : 3300 mm
 $\Delta R = 0,18 \text{ m}^2 \cdot \text{K/W}^*$

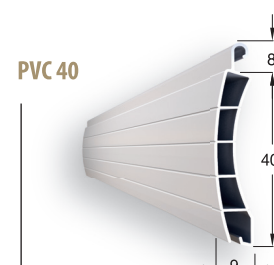

PVC 40

Poids : 3,07 kg /m²
 Surface maxi tablier : 4,32 m²
 Largeur maxi tablier : 1800 mm
 $\Delta R = 0,23 \text{ m}^2 \cdot \text{K/W}^*$

■ Normes

Thermiques :

Acoustiques :

Classement perméabilité à l'air :

Uc = 0.9 W/m2.K

Rapport AC03-095/1

Rapport BV01-364



■ Cotes mini dos de coulisses selon manœuvres

	CRX
Radio Zuni R	635
Radio Zigbee	635
Radio RS100	628
Radio IO et RTS	633
Filaire (moteur court)	633
Zuni R Solaire	775
Solaire RTS	737

■ Limites d'enroulement avec ou sans isolant thermique (= hauteur coulisses)

Alu Ev 39	2525 mm (64 lames)
Alu Ev 45	2250 mm (50 lames)
PVC 40	2270 mm (56 lames)

■ Largeur maxi

Alu Ev 39	2400 mm
Alu Ev 45	2400 mm
PVC 40	1800 mm

■ Longueurs tube TO

1000 mm	201060016 (blanc)
1200 mm	201060017 (blanc)
1400 mm	201060018 (blanc)
1600 mm	201060019 (blanc)
1800 mm	201060020 (blanc)
2000 mm	201060021 (blanc)

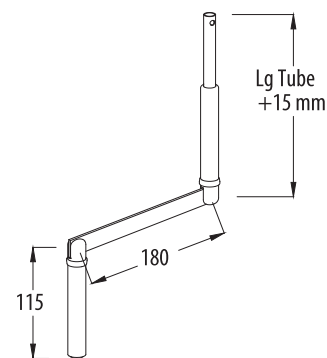

RAPPORT Acoustique

	CRX 140
	Sous Linteau
	Tablier enroulé
Standard	45 dB
Rapports	AC03-095/1 - 5
Avec Iso dB - Trappe	50 dB
Rapports	AC03-095/1 - 7

Automatismes COMMANDES



avec retour d'information

La motorisation radio ouverte à la maison intelligente d'aujourd'hui et de demain

Les commandes individuelles

Les commandes générales



Commande individuelle
portable radio



Commande individuelle
murale radio



Commande générale intuitive
avec retour d'information + 10 horloges



sans retour d'information

Le confort de la radio en toute simplicité

Les commandes individuelles



100% compatible,
idéal en rénovation
et complément de chantier



OPY
Commande individuelle
murale radio



UNO
Commande individuelle
portable radio



DOT
Inverseur filaire
intégrant un récepteur radio
Rend une installation filaire compatible
avec une installation radio
(sauf pour le Zuni R solaire)



Les commandes individuelles

Les commandes générales



Smoove
Sans retour
d'information



Situio IO 1
Sans retour
d'information



Situio IO 5
5 canaux



Nina
Création de
scénarios



Nina Timer
Création de scénarios
+ horloge

ain

La box



Calyps'HOME

Box Calyps'home
connecte votre maison
à votre smartphone

Les compléments



Dongle
rend compatible
votre moteur ZigBee avec
l'univers Tahoma de Somfy
ou Tydom 1.0 de Delta Dore

Récepteur ZigBee
rend compatibles les équipements
annexes de votre maison
(PG, portail, BSO, lumières ...)

Les commandes générales



DUO

Commande générale
2 zones



NOÉ

Commande générale
portable 8 canaux
+ gestion horaire par horloge



TAO

Télécommande zuni
qui à la fois pilote votre
porte de garage et ferme
tous vos volets roulants



Récepteur universel
Rend compatible votre
portail, quelle que soit
sa marque, avec
l'ensemble de la maison

Calyps'HOME



Dongle Zuni R

Rend compatible votre
moteur Zuni R avec la
box Calyps'home et la
box Tahoma V2 de Somfy

La box

Les compléments



Horloge 1 zone



Tahoma Box



Capteur solaire
compatible avec
la box Tahoma

Secteurs commerciaux **Fabricants de menuiserie**

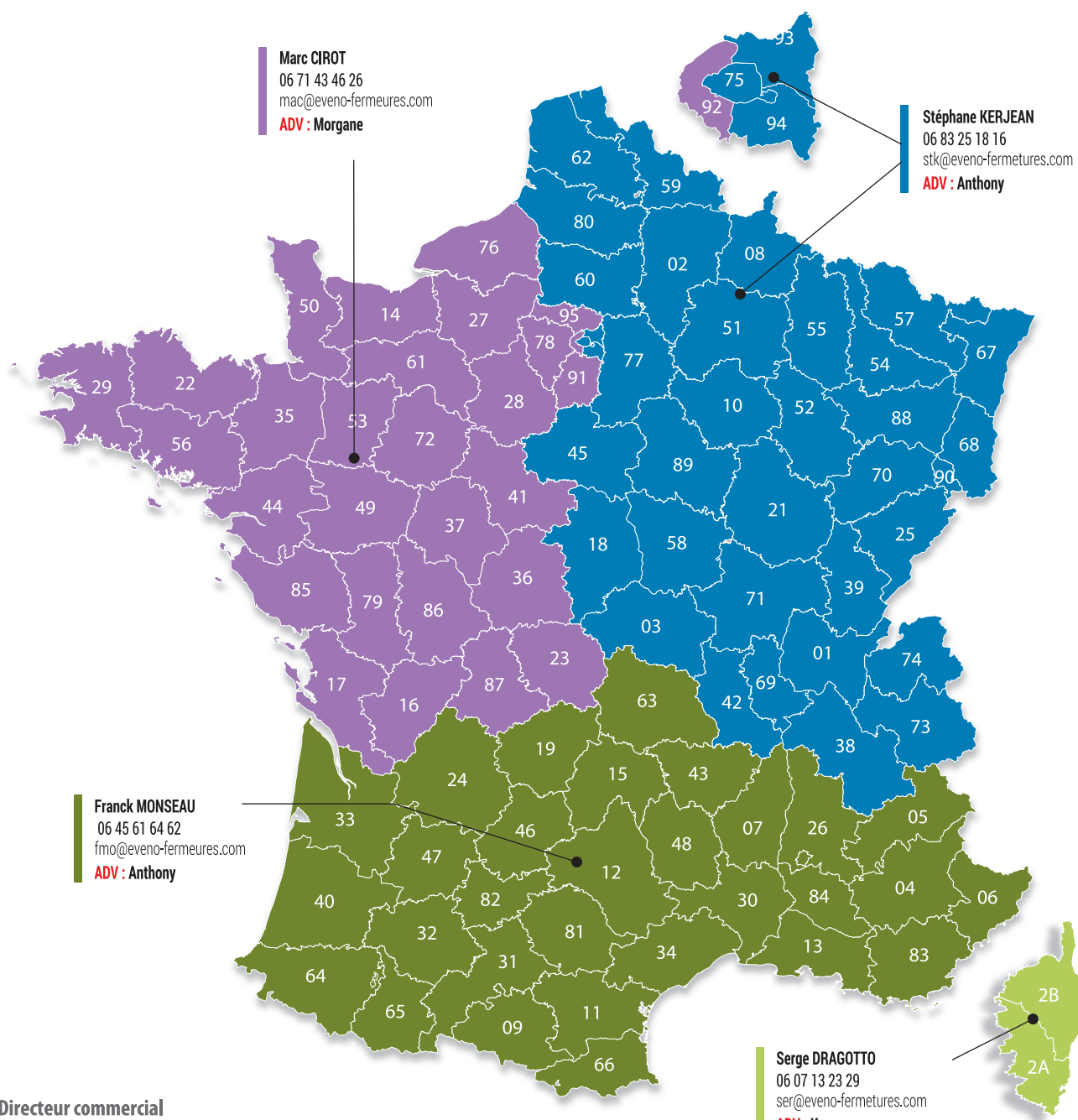

**Directeur commercial
et Marketing**
Stéphane VIGNAUD
stv@eveno-fermetures.com







Memento

Cahier technique

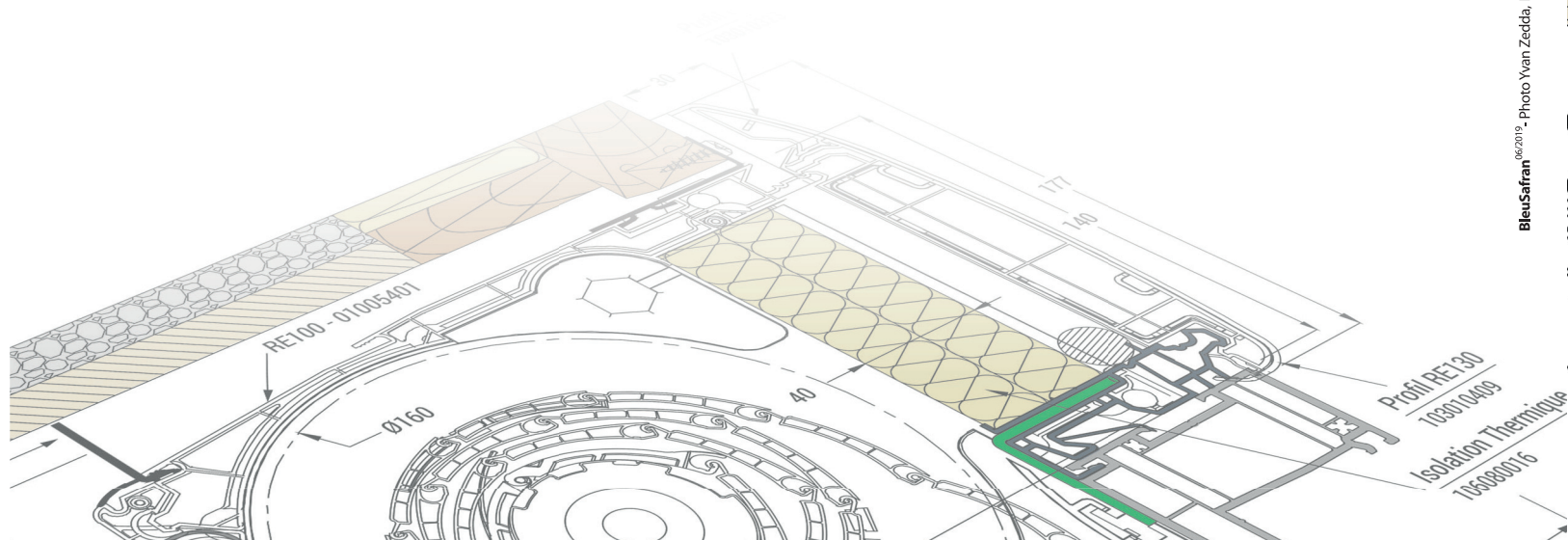

BleuSafran 06/2019 - Photo Yan Zedda, Eveno, images 3D Pix Factory

EVENO

Les éléments de votre Confort

Z.I. du Gaillac - 56276 PLŒMEUR Cedex
contact@eveno-fermetures.com
www.eveno-fermetures.com



Eveno est sur [Twitter](#)